



Alfa Laval LeviMag[®], Magnetic Mixer

Levitated Magnetic Mixer

Application

Alfa Laval LeviMag magnetic mixers offer effective mixing for multiple processes within Dairy, Beverage and Food applications - eg. aseptic or sterile storage or buffer tanks - where high demands on hygienic and aseptic design are required. Due to the compact design the LeviMag is also an obvious choice for low level agitation.

Depending on duty and media properties the LeviMag can be configured to be used in tanks from 30 l. to 40.000 l.

Working principle

A radial turbine installed inside the tank is rotated via the torque from a magnetic coupling. This creates mixing of the fluid inside the tank. The patented levitated design of the impeller makes the mixer fully drainable and able to run dry - hence it can mix to the last drop, securing maximum yield.

Unique features

Levitated design: Makes the bearing fully drainable and minimize wear of the bearing.

Replacable bearings: Both the female and the male bearing can be replaced by the end user on site.

High efficiency impeller: The impeller unit is flow optimized, which creates the possibility of gentle product treatment

Mixing to last drop: Dry running capability makes it possible to achieve maximum yield.

Available versions:

- Impeller with male/female bearing
- Impeller complete, with drive unit

Drive unit versions:

- Painted (fan ventilated)
- Clean room finish, Sealed Surface Conversion Treatment (smooth, closed, none fan ventilated)
- Extended console for insulated tanks



TECHNICAL DATA:

Internals:	
Product Wetted Surface finish:	Ra <0.8 µm Mech. Polished
Working pressure:	-1 to 7 bar(g)
Impeller diameters:	100, 150, 200, 250 & 300 mm
Weld Plate:	
Size WP50:	For impeller size 100 & 150 mm
Size WP81:	For impeller size 200, 250 & 300 mm
Drive Unit:	
Motor:	
Integrated Permanent Magnet Synchron Motor (IPMSM) which has to be operated with a frequency inverter for IE4 motors. The frequency converter (not Alfa Laval supply) must be ordered for the voltage available at the place of operation.	
Efficiency class:	IE4
Enclosure / Motor protection:	IP66
Configuration:	Blue
Nominal Power:	1.1 kW
Nominal Voltage and frequency (from frequency converter):	Output 217 VAC, connected in delta, 70 Hz, 2100 RPM
Nominal Current:	3.59 A
Configuration:	Clean room, WP50
Nominal Power:	0.75 kW
Nominal Voltage and frequency (from frequency converter):	Output 199 VAC, connected in delta, 70 Hz, 2100 RPM
Nominal Current:	2.53 A
Configuration:	Clean room, WP81
Nominal Power:	1.1 kW
Nominal Voltage and frequency (from frequency converter):	Output 195 VAC, connected in delta, 70 Hz, 2100 RPM
Nominal Current:	3.61 A
Country Code:	All (one type covers all)
Gear:	
High efficiency helical bevel right angle gearbox.	
Lubricant:	Food compatible oil
Maximum mounting angle acc. to horizontal:	0° - 45° (Different angle intervals based on configuration - Note: Motor may not point down wards)
Surface finish drive unit, standard:	Painted Blue RAL 5010
Surface finish drive unit, Clean Room option:	Sealed Surface Conversion Treatment, Smooth Body (no fan)
Console/flange:	
Standard height or option for extended height for insulated tanks.	
Attachment, Size WP50:	Clamp connection
Attachment, Size WP81:	Flange-bolt connection

PHYSICAL DATA

Materials:	
Impeller and Weld plate:	AISI316L (UNS S31603)
Drive Rotor, shaft and console/flange:	AISI304 (UNS S30400)
Gear motor , Painted:	C2 according to DIN 12944 (NSF/ANSI 51-2009e)
Gear motor, Clean room	Permanent Bond Surface (nsd tupH) - compl. w. FDA Title 21 CFR 175.300
Male Bearing:	Zirconia YTZP
Female bearing:	Silicium Carbide (EN 12756)
Seals:	FEP/FKM
Gearbox oil:	USDA H1
Temperatures:	
During product Mixing, media:	Max. 90°C
During CIP (max. 50 RPM):	Max. 95°C
During SIP (0 RPM):	Max. 150°C
Max. speed:	
Impeller size 100	800 RPM (81 Hz)
Impeller size 150	480 RPM (48.5 Hz)
Impeller size 200	480 RPM (83 Hz)
Impeller size 250	230 RPM (40 Hz)
Impeller size 300	200 RPM (34.5 Hz)

Documentation:

As standard with Q-Doc including:

- Compliance with Regulation (EC) No.: 1935/2004
- Compliance to the EC Regulation for GMP
- 3.1 Material Certificates acc. to EN10204 (MTR) for all wetted parts
- Compliance to FDA CFR 21 (non-metallic parts) for elastomers, ceramics and gear oil.
- TSE (Transmissible Spongiform Encephalopathy) / ADI (Animal Derivative Ingredient) Declaration
- Surface finish compliance declaration

Build up:

1. Impeller
2. Seals
3. Female Bearing
4. Male Bearing
5. Weld Plate
6. Clamp ring connection (WP50 only)
7. Flange-Bolt Connection (WP81 only)
8. Drive unit

LeviMag WP50

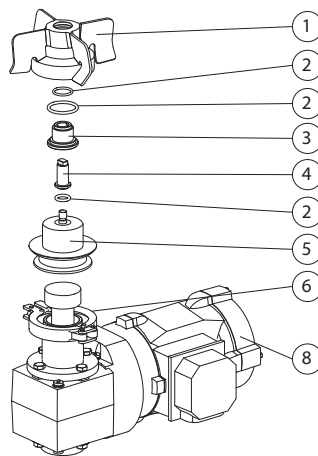

LeviMag WP81

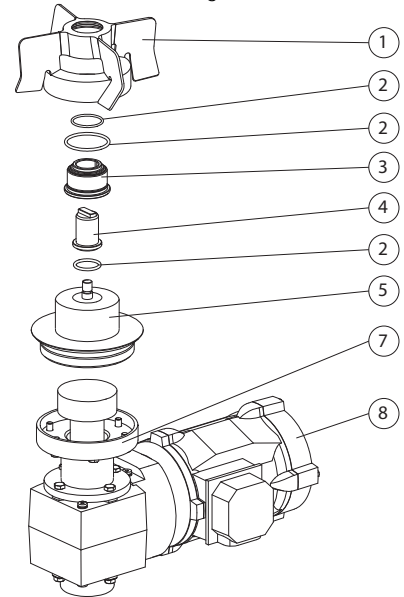

Dimensions:
LeviMag WP50

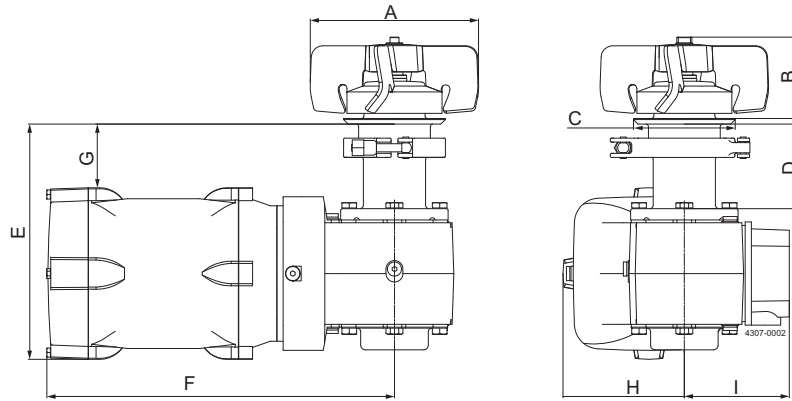

Model	Size WP50 - Ø100 impeller				Size WP50 - Ø150 impeller			
	Standard console	Extended console	Standard console	Extended console	Standard console	Extended console	Standard console	Extended console
Configuration	Height + Painted	Height + Painted	Height + Clean Room	Height + Clean Room	Height + Painted	Height + Painted	Height + Clean Room	Height + Clean Room
	Gear Motor	Gear Motor	Gear Motor	Gear Motor	Gear Motor	Gear Motor	Gear Motor	Gear Motor
A	Ø100	Ø100	Ø100	Ø100	Ø150	Ø150	Ø150	Ø150
B	72	72	72	72	72	72	72	72
C	Ø89	Ø89	Ø89	Ø89	Ø89	Ø89	Ø89	Ø89
D	75	125	75	125	75	125	75	125
E	215	265	209	259	215	265	209	259
F	340	340	308	308	340	340	308	308
G	50	100	57	107	50	100	57	107
H	114	114	108	108	114	114	108	108
I	111	111	93	93	111	111	93	93

LeviMag WP81

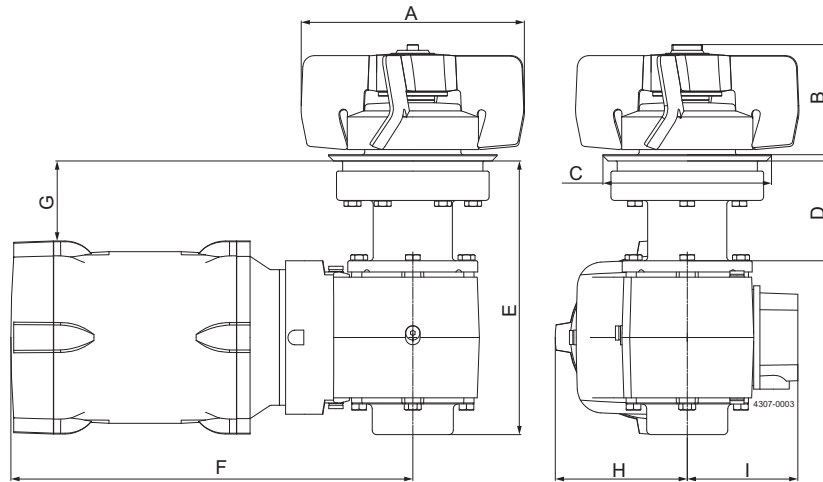

Model	Size WP81 - Ø200 impeller				Size WP81 - Ø250 impeller				Size WP81 - Ø300 impeller			
	Standard console	Extended console	Standard console	Extended console	Standard console	Extended console	Standard console	Extended console	Standard console	Extended console	Standard console	Extended console
Configuration	Height + Painted	Height + Painted	Height + Clean Room	Height + Clean Room	Height + Painted	Height + Painted	Height + Clean Room	Height + Clean Room	Height + Painted	Height + Painted	Height + Clean Room	Height + Clean Room
	Motor	Motor	Gear Motor	Gear Motor	Motor	Motor	Gear Motor	Gear Motor	Motor	Motor	Gear Motor	Gear Motor
A	Ø200	Ø200	Ø200	Ø200	Ø250	Ø250	Ø250	Ø250	Ø300	Ø300	Ø300	Ø300
B	98	98	98	98	98	98	98	98	98	98	98	98
C	Ø149	Ø149	Ø149	Ø149	Ø149	Ø149	Ø149	Ø149	Ø149	Ø149	Ø149	Ø149
D	89	139	89	139	89	139	89	139	89	139	89	139
E	243	293	243	293	243	293	243	293	243	293	243	293
F	354	354	357	357	354	354	357	357	354	354	357	357
G	74	124	70	120	74	124	70	120	74	124	70	120
H	114	114	117	117	114	114	117	117	114	114	117	117
I	111	111	98	98	111	111	98	98	111	111	98	98

Machine Selection:

LeviMag UltraPure can be sized and configured in Alfa Laval configurator.

Selection of size can also be done by use of the below selection charts.

Needed information for selection of size:

- Media Viscosity
- Tank Volume
- Tank diameter and tank bottom shape.
- Duty (see below Duty Levels)

Duty Level	Duty	Description
1	Keep media homogenous	Keeping fluids homogenous & low gradient heat transfer
2	Mild blending	Simple blending of miscible fluids & high gradient heat transfer, no specific request to mixing time, create suspension if deposit velocity is below 0.015 m/s
3	Mixing	Mixing of fluids, relative low mixing time, create suspension if deposit velocity is below 0.03 m/s
4	Powerful mixing	Dissolving solids, very low mixing time, create suspension if deposit velocity is below 0.06 m/s.

Preconditions for using the selection charts:

- Liquid height must be equal to or lower than 2 times the tank diameter
- if duty involves suspension of particles (see deposit velocity limits in the duty levels), the tank diameter D must be:

$$D \leq \sqrt[3]{\frac{V * 4}{\pi}}$$

where V is the net. Volume.

- If preconditions are not fulfilled please contact Alfa Laval Global Technical Support

How to select:

1. Select duty
2. Check preconditions
3. Go to the chart for the chosen duty
4. Read out the point for the requested tank volume (X-axis) and viscosity (Y-axis)
5. Choose the curve to the right from the point
6. If physically possible a larger impeller size can always be chosen - eg. to obtain a gentler product treatment (operating at lower speed)

Duty Level 1: Keep media homogenous
Volume vs. viscosity

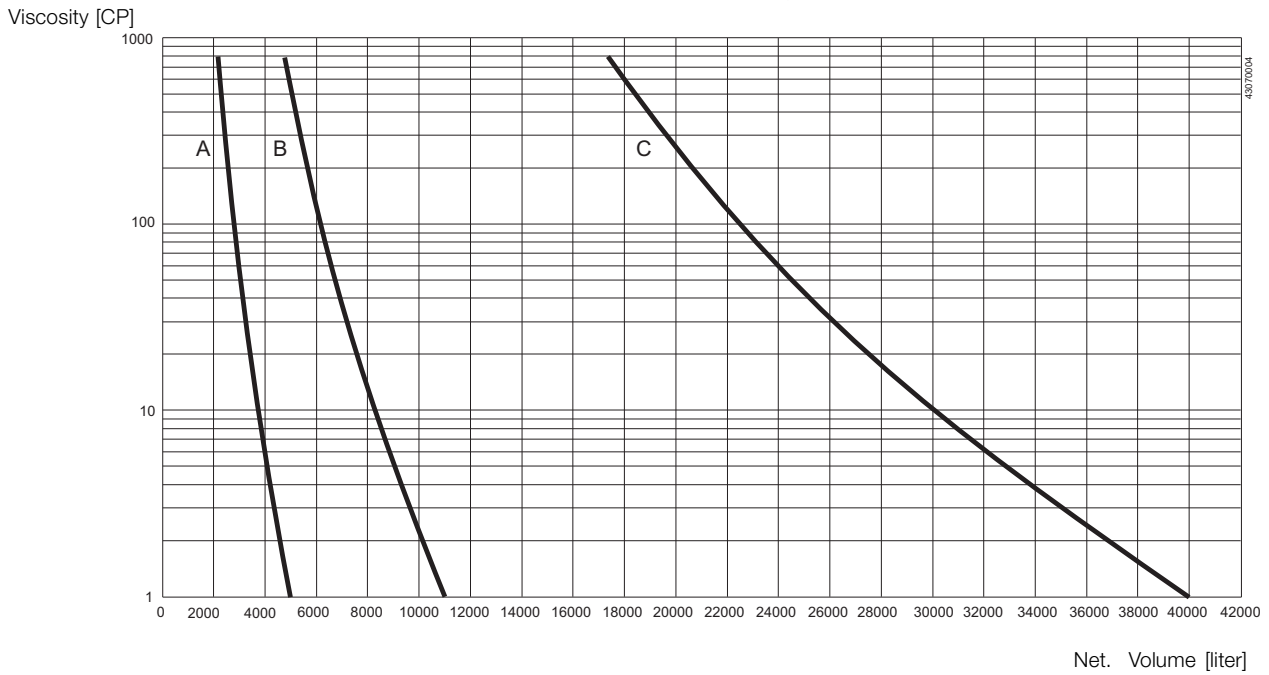

- A: LeviMag size 100 mm
- B: LeviMag size 150 mm
- C: LeviMag size 200, 250 and 300 mm

Duty Level 2: Mild blending
Volume vs. viscosity

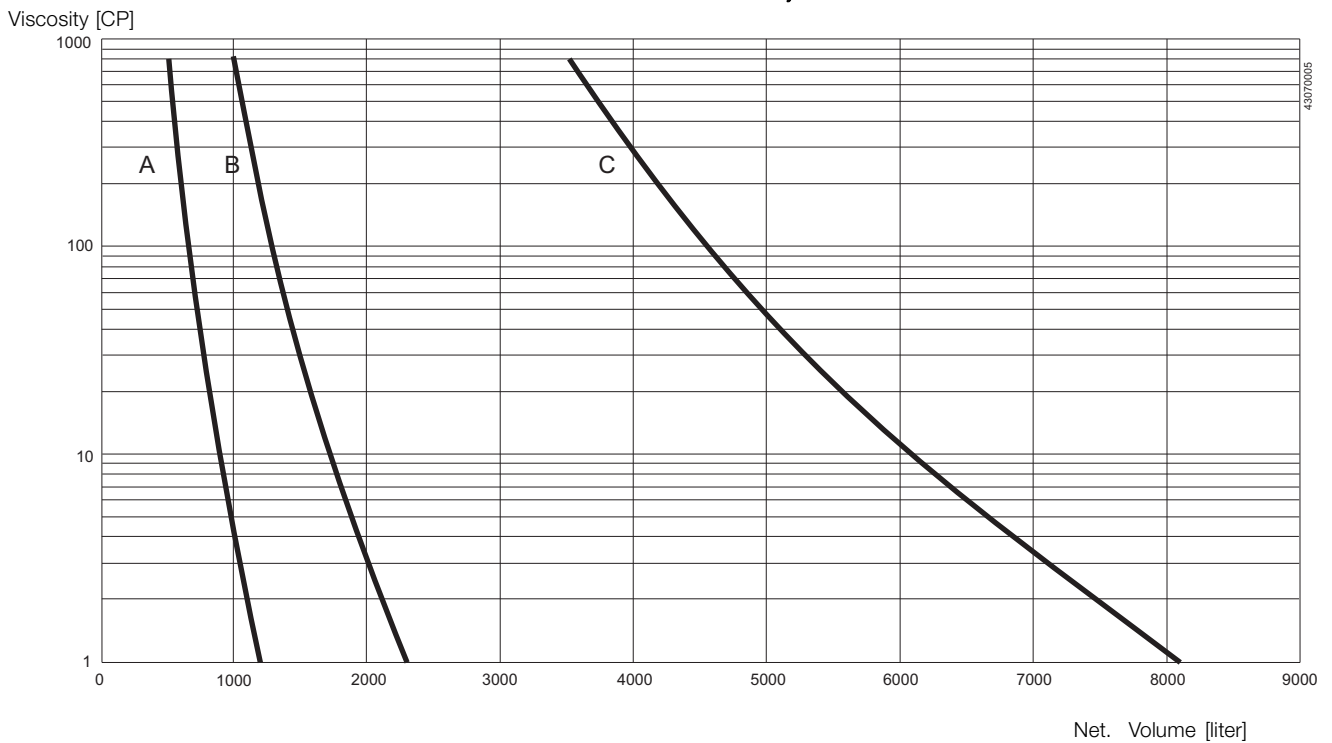

- A: LeviMag size 100 mm
- B: LeviMag size 150 mm
- C: LeviMag size 200, 250 and 300 mm

Duty Level 3: Mixing
Volume vs. viscosity

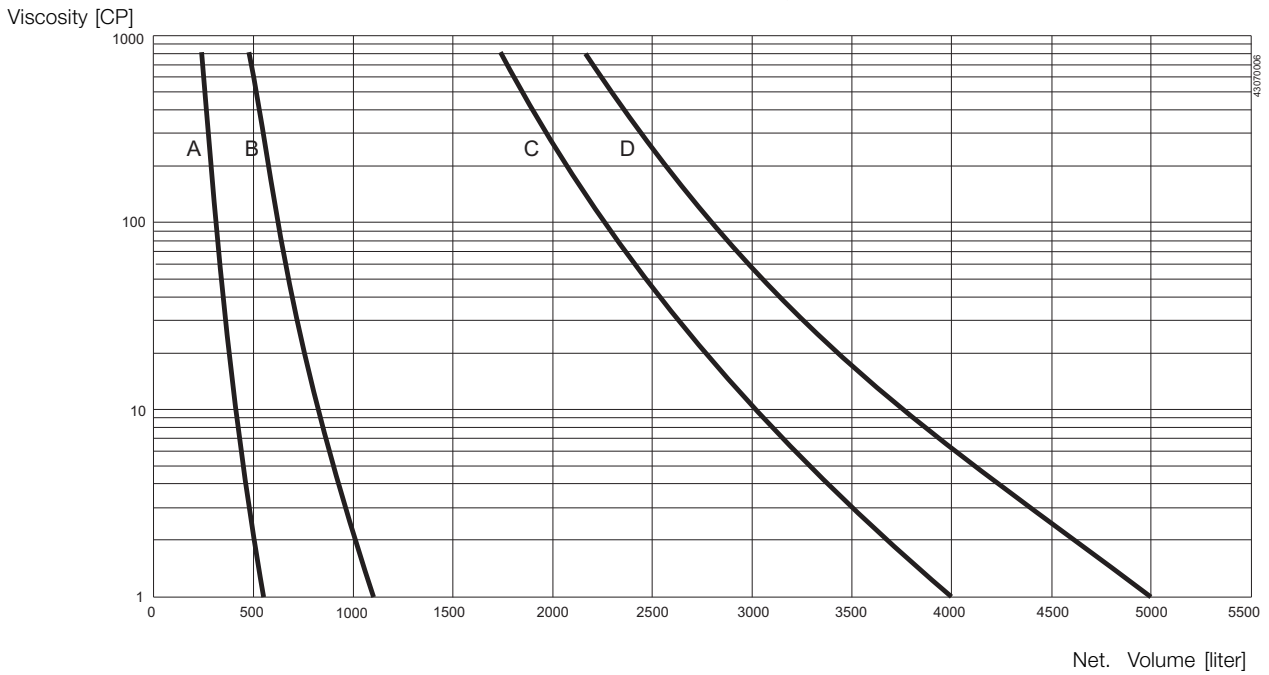

- A: LeviMag size 100 mm
- B: LeviMag size 150 mm
- C: LeviMag size 200, 250 and 300 mm
- D: LeviMag size 300 mm

Duty Level 4: Powerfull mixing
Volume vs. viscosity

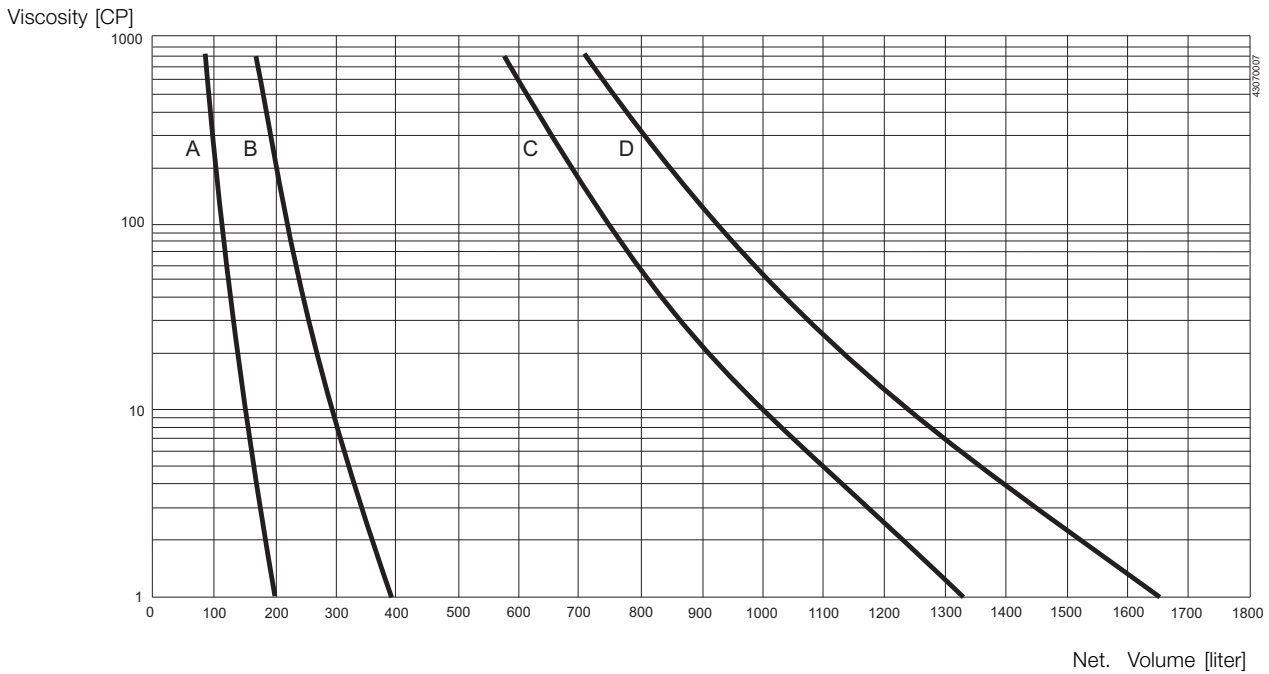

- A: LeviMag size 100 mm
- B: LeviMag size 150 mm
- C: LeviMag size 200, 250 and 300 mm
- D: LeviMag size 300 mm

Alfa Laval reserves the right to change specifications without prior notification.

How to contact Alfa Laval

Contact details for all countries
are continually updated on our website.
Please visit www.alfalaval.com to
access the information direct.